



# MERREEN-JOHNSON

---

## DOUBLE END TENONERS



---

## FAST, ACCURATE, RELIABLE





# Leading Technology

Fast, Accurate, High Speed Production

Lasting Performance

Hold Downs: Interlocking block, air or spring roller, and belt type hold downs available



Four Station Tenoner shown with optional sound enclosure and integral dust extraction plenum



End joinery



HSK and Stacked Tooling Options



CNC Contouring and Angle Gain Capability



Trim Motors in combination with Jump Scores



High Speed Profiling Copes

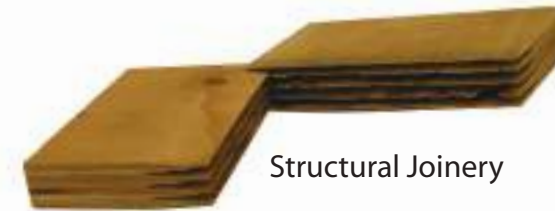

Structural Joinery



Flat and Profile Belt Sanders



Abrasive Wheel Sanders

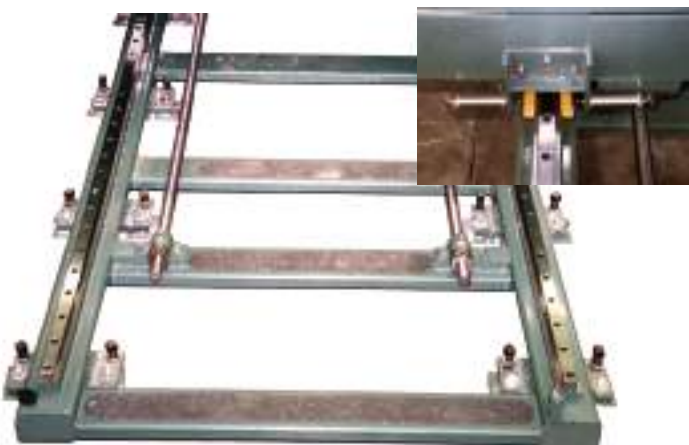

Machine Base: Heavy wall structural steel weldment with linear rails and air actuated position lock



Feed Chains: smooth, corrugated, or padded surface. Snap-in, bolt-on, clamp-up, or pop-up type feed lugs.



Panel Production



Stationary and Jump Dado Beams



Boring Stations



# Custom Designed to Meet Your Specific Application Requirements

Choose the right capacity and machining stations

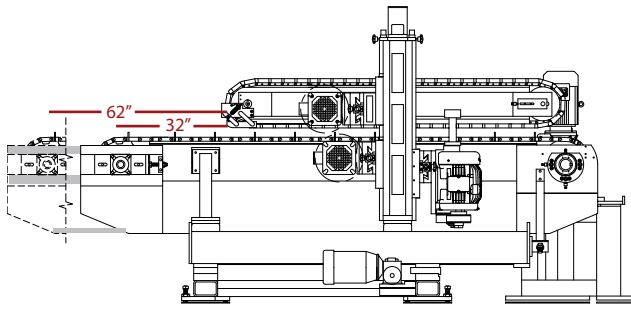

Two Station Machine Center

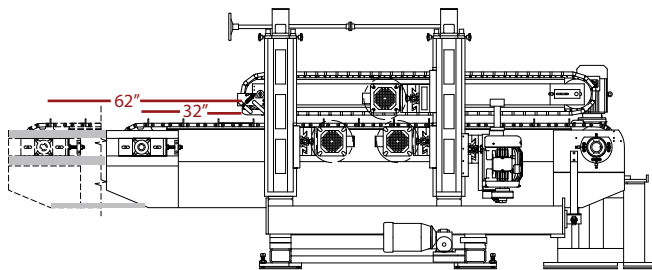

Three Station Machine Center

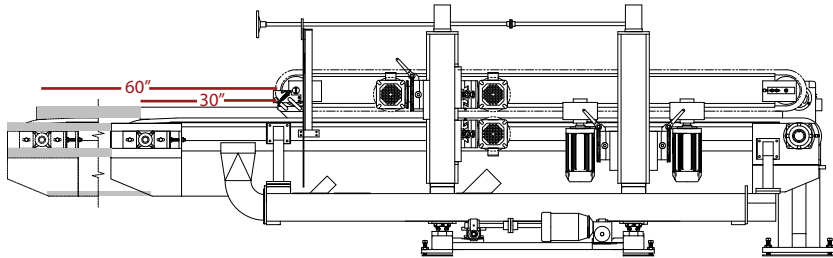

Four Station Machine Center

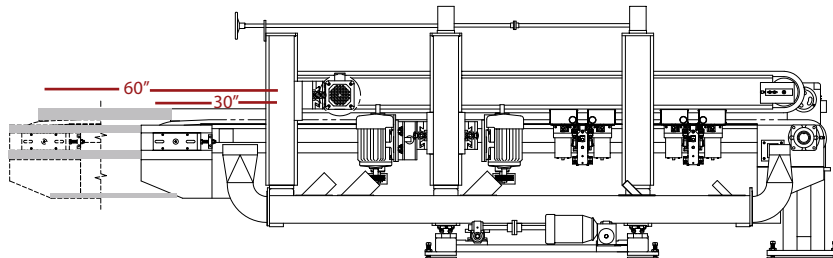

Five Station Machine Center

\*Note: Actual capacities and station arrangements may vary.  
Custom design and engineering services also available.

Custom controls and automation to reduce labor,  
minimize set-up times, and increase production

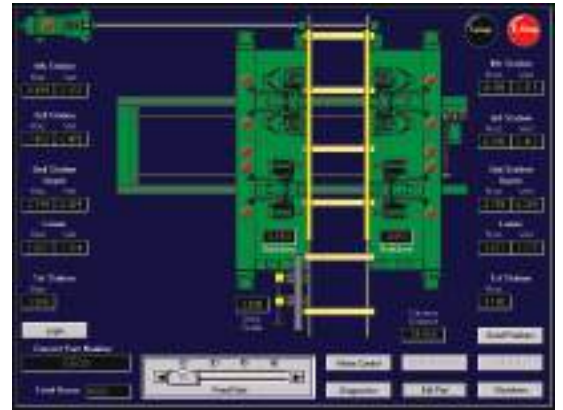

Typical CNC set-up screen



Infeed tenoner transfer with metering belts



Part rotation transfer



Lift gate transfer chains



Tenoner to moulder transfer

